

BEDIENUNGSANWEISUNG

mit Montageanweisungen

- Ⓜ GB Instructions for use and installation instructions
- Ⓜ F Instructions d'utilisation et avis de montage
- Ⓜ NL Gebruiksaanwijzing en montagehandleiding

EEB 6500.0

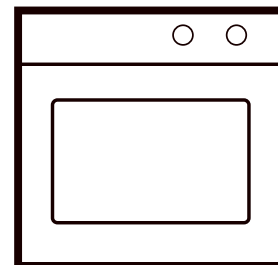

For your information...

You should carefully read the information in this manual before you use your oven. Here you will find important notes concerning safety and how to use, look after and service your appliance so that it enjoys a long service life.

Should a fault arise, please first consult chapter "What to do if trouble occurs". You can often remedy minor faults yourself and thus save unnecessary service costs.

Please keep this manual in a safety place and pass it on to new owners for their information and safety.

The following symbols are used in this operating manual:

 The warning triangle draws your attention to risks to your health or damage that might be caused to your appliance.

 Here you will find useful hints and information.

Conditions of guarantee

The conditions of guarantee applicable for this product are subject to those published by the representative in the relevant country.

Details regarding same may be obtained from the dealer from whom the appliance was purchased. For claims under guarantee the sales receipt must be produced.

Contents

Your appliance at a glance	20
Safety instructions	21
Connection and operation	
Oven	
Before using the appliance for the first time	21
Disposing of the packaging and the old appliance	
Setting the clock	
Initial cleaning	
Using your oven.	22
General	
Controls and displays for the oven	
Symbols and operating modes	
Heating-up indicator and pilot light	
Turning the oven light on and off	
Turning the oven on and off	
Oven trays	
Rack levels:	
backmobil® (acc.-no. 600)	
Telescopic glide-out shelves (acc.-no. 601)	
Fast preheating	
Roasting	
Recommended temperatures for roasting	
Baking	
Baking pizza	
Tips on the table "Recommended temperatures for baking"	
Recommended temperatures for baking	
Grilling	
Recommended temperatures for grilling	
Defrosting	
Preserving	

The electronic timer	27
Setting/changing the clock	
Setting the alarm time	
This is how to programme the switching operations	
Changing the setting	
When the cooking time is finished	
Setting the cooking time \rightarrow (switch-off function)	
Setting the finish time \rightarrow (switch-off function)	
Automatic turn-on and shut-off	
Cleaning and care	29
For all surfaces	
Remove caking	
Please note the information for the cleaning scraper	
The use of oven sprays - information	
Enamel	
Stainless steel	
Glass	
Aluminium	
Door sealing	
Buttons	
Removing and installing the oven door	
Removing and installing the side racks	
Folding heating element down/up	
Regenerating the ökotherm® catalyst	
What to do if trouble occurs...	31
Replacing the oven lamp	
Replacing the door sealing	
Rating label	31
Installation instructions for fitter.	32
Electrics	
Installation dimensions	
Installation in a fitted kitchen	

Your appliance at a glance

- 1 Control buttons for the electronic timer
- 2 Electronic timer display
- 3 Pilot light (yellow)
- 4 Heating-up indicator (red)
- 5 Mode selector
- 6 Temperature control
- 7 Control panel
- 8 Fold-down grill (top heat and grill)
- 9 Hot air fan
- 10 Rack levels
- 11 Oven door

Accessories supplied:

- Gridiron
- Baking tray (enamel)
- Drip pan
- Grilling rack with lifter

Accessories available:

- Grilling rack with lifter (acc.-no. 125)
- Pizza stone (acc.-no. 145)
- Gridiron (acc.-no. 124)
- Roasting tray (acc.-no. 441)
- Baking tray (enamel) (acc.-no. 541)
- Drip pan (aluminium) (acc.-no. 542)
- Drip pan (acc.-no. 543)
- backmobil[®] (acc.-no. 600)
- Telescopic glide-out shelves (acc.-no. 601)

Accessories available

for the telescopic glide-out shelves (acc.-no. 601):

- Gridiron, depressed, e.g. for large poultry (acc.-no. 750)
- Glass drip pan, suitable only for accessory 750 (acc.-no. 751)

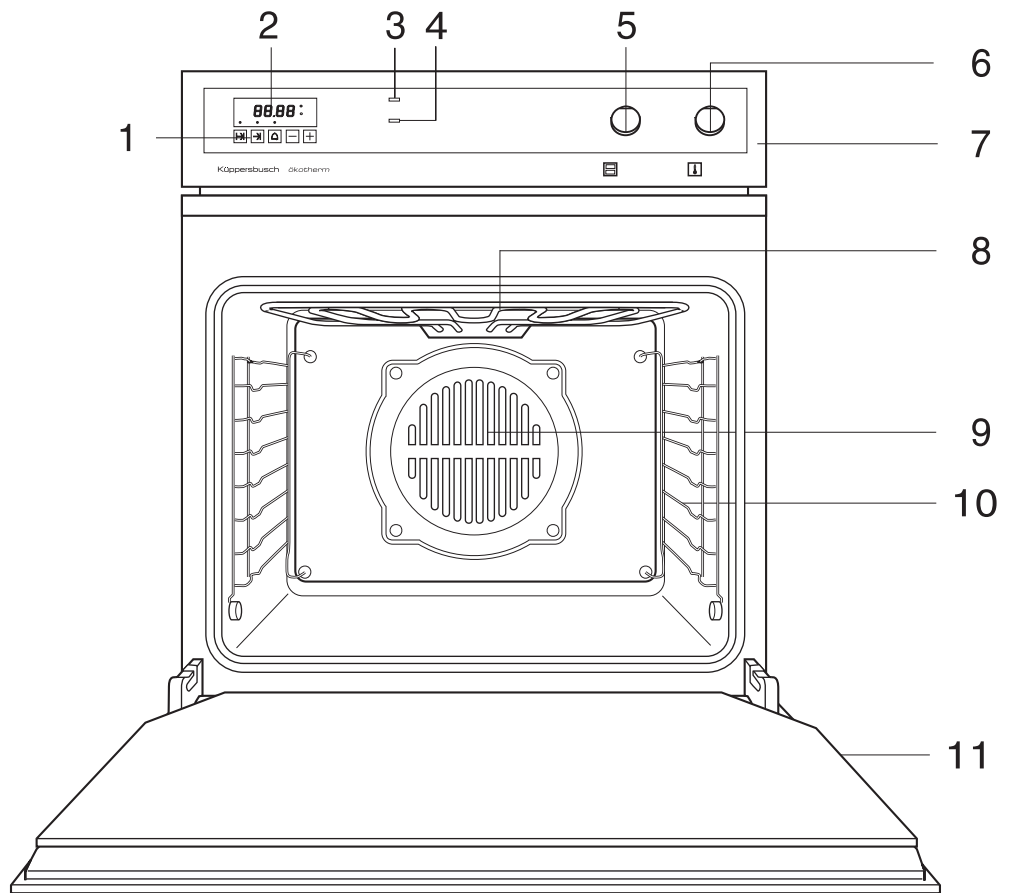

Safety instructions



Connection and operation

- Küppersbusch fitted ovens may only be connected to the corresponding Küppersbusch fitted hobs by a qualified and authorised fitter.
- The appliances may only be connected to the mains, maintained and repaired by a qualified electrician according to valid safety regulations. Work carried out incorrectly places your safety at risk.
- Do not put the appliance into operation unless it has been built in!
- The surfaces of the oven door and the appliance are very hot when in operation. Always keep children away!
- Connection leads of electrical appliances may not be placed on the hot cooking zones or get jammed in the hot oven door.
- Steam and/or pressure cleaning machines must not be used to clean the oven! This can damage the unit resulting in risk of **personal injury**.
- The appliance is to be used only for the preparation of food in the home.

Oven

- When carrying out repairs and replacing oven light bulbs, the cooker must be disconnected from the mains (switch off the fuse or unplug from the mains).
- Never store any objects in your oven which could cause a hazard if the oven is unintentionally switched on.
- Take special care when working in the hot oven. Use a dish cloth, oven gloves or similar.
- Be careful opening the door when the oven is hot: don't lean over the open door straight away. As soon as you open the door, hot air and even steam will spill out through the door opening.
- The oven door must close well. In the event of damage to the hinges or to the glass pane, do not use the appliance until it has been repaired and checked by a qualified person.
- A damaged door sealing must be replaced. The oven must not be used with damaged door sealing.
- Always close the oven door completely when preparing food in the oven.
- Keep it at a distance of at least 5 cm from the grill and top heat.

Before using the appliance for the first time

Disposing of the packaging and the old appliance

Dispose of the transport packaging in such a way that it does not impact on the environment.

If the appliance is purchased in Germany, the dealer who sold you the appliance will dispose of the transport packaging for you. Recycling the packaging saves raw materials and reduces the amount of waste. Disposed appliances still contain useful materials. Dispose of your old appliance at a collection point for recycling useful materials. Before disposing of your old appliance ensure that it cannot be used any longer. This will prevent misuse.

Setting the clock

☞ **The oven will not function until the clock is set.**

The clock must be set before the oven is used and whenever power has been disconnected to the appliance. If the clock needs to be set, you will see "0.00" flashing in the display.

- Use "+" and "-" to set the right time. After around 3 seconds, the new time will be accepted and the display will stop blinking.

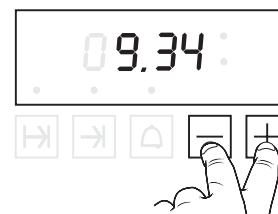

Initial cleaning

- Remove foreign matter and packaging.
- Before preparing food for the first time, **the appliance must be cleaned.** Clean the drip pan, gridiron etc. with a damp cloth and a little detergent.
- **Heating the oven.** Close the oven door. Heat up the oven with top heat/bottom heat at 250 °C for 60 minutes. Air the kitchen well at the same time.

Using your oven

General

- ⚠ Please note the safety instructions on page 21!
- ⚠ **Attention. Risk of overheating!** Do not cover the bottom of the oven with aluminium foil and do not place pots or pans directly on it! This would cause a build-up of heat that would damage the enamel.
- 👉 When the oven is in use, it becomes hot. In order to cool the housing, the cooling fan is switched on as soon as the housing heats up. The cooling fan continues to run until the housing has cooled down - even after the appliance has been switched off. The fan noises are normal running noises and not a fault.
- 👉 If you are cooking a dish in the oven that contains alcohol or yeast, the Hot air convection, Intensive hot air convection and Pizza Mode will result in a vinegar smell. If you find the smell disturbing, use one of the other modes, such as Top/Bottom Heat.

Controls and displays for the oven

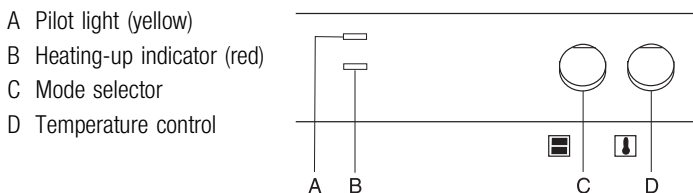

Symbols and operating modes

Switch symbol	Operating mode	intended for
0	Off	
	Lighting	
	Cold air convection	without temperature setting, for gently defrosting and cooling food.
	Hot air convection	with temperature setting, for roasting, baking and cooking on several levels.
	Top heat/ Bottom heat	Preheating, baking and roasting on one level
	Bottom heat	Prebaking very moist cake
	Top heat	Browning toppings
	Grilling	Grilling small portions. Position the pieces of meat in the centre of the gridiron.
	Large area grill	Grilling larger portions such as steaks, fish and sausages, but also for browning toast dishes and gratins.
	Intensive hot air convection	Baking large flat cakes with a dry topping (such as a crumble topping), intensive roasting of large joints and large poultry such as goose or turkey.
	Pizza mode	Baking bread, pizzas and moist cakes, making preserves.

Heating-up indicator and pilot light

The heating-up indicator on the control panel will light up while the appliance is heating up and will go out as soon as the set temperature has been reached. It also comes on during operation when the oven is heated to maintain the temperature you want.

The pilot light lights up when you have selected an operation mode – the oven is operating.

Turning the oven light on and off

The oven lighting stays on when the mode selector is up – except on position 0. The light stays off when the mode switch is depressed.

The oven light functions regardless of which mode is selected. The light can also be turned off while the oven is in use. This will save energy and increase the life of the lamps.

Turning the oven on and off

- 👉 The controls are of the pop-out type and can be countersunk in every setting. They pop out at a slight press of the finger. No settings can be made while the controls are countersunk.

Selecting the operating mode:

- Turn the mode selector (the switch on the left) to the right.

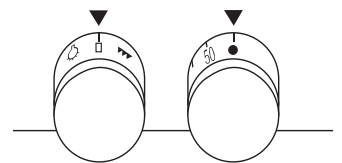

Selecting the temperature:

- Turn the temperature control (the 2nd switch from the left) to the right.

Turning the oven off:

- Turn both switches to the “0” position.

Oven trays

Baking trays:

- Lift slightly when removing. After baking trays are placed back into the oven, the sloping edge of the tray must point towards the oven door.
- Push the drip pan and baking tray with the two slots right at the back into the oven.

Gridiron:

- Please ensure that the catches of the racks always point towards the back (away from you).

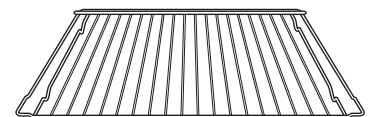

Grilling rack with lifter to insert in the dripping pan

- The grilling rack is inserted in the drip pan. With the lifter you can remove the grilling rack together with the drip pan from the oven. Nothing drips and you can easily serve.

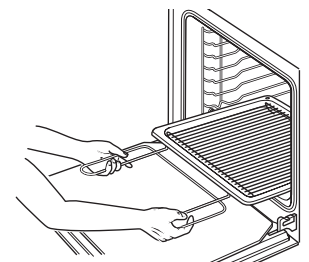

Roasting tray as splash guard for roasting and grilling (accessory)

- The roasting tray is inserted in the drip pan and prevents the fat from splashing out of the drip pan.

Rack levels:

You have 8 levels in the side racks. The rack levels are numbered from 0 to 7 from the bottom up. For example, the drip pan can be inserted into rack level 0.

Side racks:

Rack level 0 is the lowest possible level.

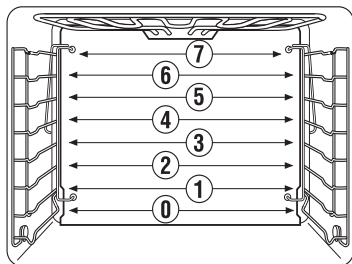

backmobil® (acc.-no. 600)

The backmobil® replaces the shelf racks in your oven and can be completely pulled out like a trolley. It can be removed from the oven and dismantled for cleaning purposes.

If your oven is equipped with a backmobil®, please read the instructions enclosed with it.

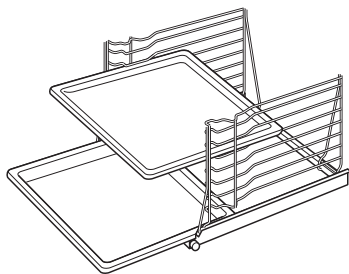

Telescopic glide-out shelves (acc.-no. 601)

are oven rails available as accessories which replace the side racks and make working in a hot oven more easy. Trays or gridirons are placed on the glide-out shelves. They can be pulled out singly and independently of each other.

If your oven is fitted with glide-out shelves, please read the instructions enclosed with them.

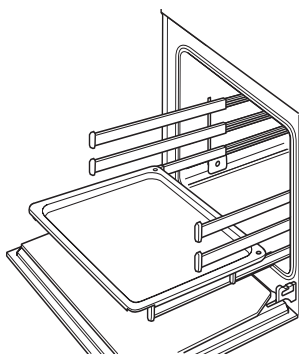

Fast preheating

Do not insert food for roasting or baking into the oven until fast preheating is over and the oven has been set to the normal mode of operation.

With the Pizza mode the empty oven can be preheated in a relatively short time.

- Close the oven door.
- Set the mode selector switch to Pizza mode.
- Set the temperature you want. The heating-up indicator comes on.
- As soon as the heating-up indicator goes off, set the mode you want.
- Put the food into the oven.

Roasting

Use the drip pan and the gridiron.

- You should only cook meat or fish in the oven if they weigh more than 1 kg.
 - The roasting time depends on the type of meat you are roasting, the quality and on the thickness of the joint.
To measure the joint, lift it slightly as it collapses under its own weight.
 - The roasting time for meat with a layer of fat can be as much as twice as long as usual.
 - If you are cooking several small pieces of meat or small poultry in the oven, the cooking time increases by about 10 min. per piece. The roasting time for a chicken is, for example, about 60 min., for 2 chickens 65 to 75 mins.
- Be absolutely certain to observe the notes on the rack levels!

Rack levels (count from bottom!):

Intensive hot air convection Drip pan: rack level 0

Gridiron: rack level 1

Hot air convection Drip pan: rack level 1

Gridiron: rack level 2

Top heat/bottom heat Drip pan: rack level 1

Gridiron: rack level 2

Roasting on the gridiron

- You can cook large roasts directly in the drip pan or on the gridiron with the drip pan inserted underneath (e.g. turkey, goose, 3-4 chickens or knuckles).
- Turn the roast after 2/3 of the cooking time unless you are using the hot air convection mode.

Roasting in a pan (oven)

Select Intensive hot air convection at 180-200 °C.

- You should roast lean types of meat in the roasting pan with the lid closed (e.g. roast of veal or marinated beef, braised beef or deep-frozen meat). The meat remains juicier that way.
- You can use any type of pan (stainless steel, enamelled, cast iron or glass) which does not have plastic or wooden handles.
- If you use an earthenware cooking pot, study the manufacturer's instructions.



We recommend the following procedure:

- Rinse out the pan with water or grease it lightly.
- After preparing the meat (adding spices), place it into the pan. Put the lid on the pan and place the pan onto the rack in the cold oven.
- Select Intensive hot air convection and set the temperature to between 180 and 200 °C.

Prepare the sauces in the usual way.

Recommended temperatures for roasting

The recommended temperatures for the preferred operating modes **have been highlighted**.

Type of meat	Hot air convection 	Top heat/ bottom heat 	Intensive hot air convection 	Roasting time
	Temperature in °C			
Joint of beef	160	170-190		18
Roast beef	180	200-220	180-200	8-10
Fillet	180	200-220	180-200	8
Veal	160	170-190	160-180	12
Roast pork	160	170-190	160-180	12-15
Smoked loin of pork	160	170-190	160-180	8
Shoulder of pork	160	170-190	160-180	12-15
Roast pork with crackling	160	170-190	160-180	12-15
Game	160	170-190		15
Wild boar	160	170-190		15
Fillet of game	180	200-220	180-200	8-10
Mutton	150-160	170-190		15
Duck	160	170-190	160-180	12
Goose	160	170-190	160-180	12
Chicken	160	180-200	160-180	8*
Turkey	160	200-220	160-180	12
Fish	160	200-220		8

*whole chicken 45 - 60 min.

Baking

Hot air convection

 No need to preheat the oven - baking is possible on several levels simultaneously.



Rack levels:

- 1 tray: 2nd rack level from the bottom
- 2 trays: 2nd and 5th rack levels from the bottom
- 3 trays: 2nd, 4th and 6th rack levels from the bottom
- 4 trays: 0th, 2nd, 4th and 6th rack levels from the bottom

- If you are baking several cakes in baking tins, about 5 to 10 minutes additional baking time will be needed for each baking tray.
- Remove the baking trays individually, depending on how well browned the cakes are.
- Bake using hot air convection  at a temperature of 160 °C if there are no instructions for baking by hot air convection in your recipe.
- **Important:** When cakes with a moist fruit topping are being baked, the development of humidity is particularly high. You should bake no more than two cakes at the same time.

Top heat/bottom heat

 Preheating - baking on one level

- Preheat the oven by pizza mode , and when the temperature has been reached, set the oven back to Top heat/bottom heat 
- Baking tins made of black metal and aluminium are particularly suitable.

Intensive hot air convection

 No need to preheat the oven - baking on one level



- Only for large flat cakes with a dry topping, such as a crumble topping.

Pizza mode

 Baking on one level

- for moist cakes
- for pizzas: preheat the oven with a baking tray or a pizza stone (accessory)
- for bread: preheat the oven

Baking pizza



 Select the Pizza mode  at 250 °C.

- If you use a pizza stone (special accessory), the pizza gets a particularly crispy base. Preheating time: at least 30 min!
Read the instructions enclosed with the pizza stone.



Basic recipe for pizza

250 g of flour, 20 g of yeast, 1/8 l of lukewarm water, 3 tablespoons of (olive) oil, salt.

Baking pizza on a baking tray

- Make a yeast dough out of the specified ingredients.
- Allow the dough to rise for approx. 30 minutes until it has doubled in size.
- Then knead the dough for a few minutes and allow it to prove for another 15 minutes.
- Preheat the oven (Pizza mode  at a temperature of 250 °C).
- Grease the baking tray.
If you are making small round pizzas, insert the baking tray into the oven now and preheat it as well.
- Roll out the dough, place on a baking tray and form an edge.
- Add any topping you want quickly so that the dough does not become moist.
- **Small pizzas:** Put topped dough onto the preheated baking tray.
- Place the baking tray in rack level 0.
- Bake for approx. 8 - 12 minutes in Pizza mode , at 250 °C.

Baking pizzas on the pizza stone

- Prepare the pizza dough as described above.
- Place the pizza stone on the gridiron and insert at rack level 0.
- Preheat the oven in Pizza mode  and at a temperature of 250 °C.
- Place the dough onto the floured lifter and add toppings quickly so that the dough does not become moist. The topped pizza must not lie too long on the lifter as otherwise the dough no longer slides off.
- When preheating is over, push the pizza off the lifter onto the hot pizza stone.
- Bake for approx. 8 - 12 minutes in Pizza mode , at a temperature of 250 °C.















Tips on the table "Recommended temperatures for baking"

The table on page 25 contains a selection of cakes etc., the necessary temperatures, cooking times and rack levels.

- Temperatures are generally given in ranges as they depend on the composition of the dough, the quantity and the shape.
- We recommend you to set the lower temperature value the first time and only select a higher temperature if necessary, e.g. if you want more browning or the baking time is too long.
- If you do not find any specific temperatures for your own recipes, use a similar cake in the table given as a reference.
- Height differences of the food can result in different degrees of browning at the start of the baking process. In this case please do not change the temperature setting. Differences in browning are offset during the course of baking.

Recommended temperatures for baking

The recommended temperatures for the preferred operating modes **have been highlighted**. Please note the tips on p. 24!

Type of cake or biscuit	Hot air convection 		Top heat/bottom heat 		Intensive hot air convection  Pizza mode 		Baking time in minutes
	rack level	Temperature in °C	rack level	Temperature in °C	rack level	Temperature in °C	
Cake mixture							
Ring cake	2	150-160	1	170-180			50-65
Tin cake	2	150-160	1	170-190			50-70
Madeira cake	2	150-160	1	160-180			60-70
Gateaux and flans	2	150-160	1	170-180			40-60
Flan bases	2	170-180	2	180-200			20-30
Fine fruit flans	2	150-160	1	170-180	2	 150-160	45-60
Small biscuits	2	150	2	170-180			15-30
Large flat cakes:							
with a dry topping	2	150-160	2	180-190	2	 150-160	25-35
with a moist topping	2	160-170	2	170-180	2	 160-170	35-50
Kneaded dough							
Flan bases	2	170-180	2	180-200			25-35
Cheese cake	2	140-150	1	160-170	2	 140-150	70-90
Small biscuits	2	140-150	2	180-190			15-35
Large flat cakes:							
with a dry topping	2	150-160	2	180-190	2	 150-160	25-35
with a moist topping	2	160-170	2	170-180	2	 160-170	30-50
Leavened dough							
Ring cake	2	150-160	1	175-180			40-65
Yeast cake	2	150-160	2	175-180			40-50
Rich sweet bread (preheated)	2	150-160	2	175-180			50-70
Small biscuits	2	140-150	2	180-200			15-30
Large flat cakes:							
with a dry topping	2	150-160	2	175-180	2	 150-160	30-40
with a moist topping	2	160-170	2	170-180	2	 160-170	30-50
Sponge cake							
Gateaux and flans	2	150-160	2	175-180			30-40
Rolls	2	170-180	2	180-200			12-25
Biscuits made with white of egg							
Meringue	2	80-90	2	100-120			80-120
Cinnamon stars	2	100-120	2	120-140			20-40
Macaroons	2	100-120	2	120-140			20-50
Other doughs							
Puff pastry	2	170-180	2	190-210			15-30
Puff pastry made with leavened dough	2	170-180	2	190-210			30-40
Puff pastry made with curd cheese	2	160-180	2	180-200			30-40
Choux pastry	2	170-180	2	190-210			30-40
Dough made with curd cheese and oil	2	150-160	2	170-180			30-40
Honey cake	2	140-150	2	170-180			20-35
Bread and pizza							
Leaven and bread made with yeast (preheat: 230 °C, prebake: 10 min., 230 °C)			2	180	1/2	 160	50-65
Bread made with yeast/white bread.	2	180	2	200	2	 180	30-50
Pretzels (preheat: 230 °C)	2	200	2	220			15-20
Pizza (preheat: 250 °C)					0	 250	8-12

Grilling

⚠ Always close the oven door when grilling!



☞ Set the operating mode Grill  for small portions or Large area grill  for large portions.

Set the temperature control to . **Exception:** With larger roasts it is better to select a temperature between 200 and 250 °C so that the roast does not burn.

Switch setting for Grill :

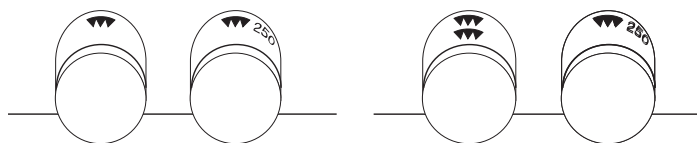
Switch setting for Large area grill :



- Preheat the oven for 5 to 10 min.
- Place the food on the gridiron.
- Push the drip pan into the 2nd or 3rd rack level and the gridiron into the rack level as per the table.
- Select Grill  or Large area grill .
- Set temperature control to .
- Close the oven door.

Recommended temperatures for grilling

Dish	Rack level	Grill		Large area grill	
		1 st side	2 ^d side	1 st side	2 ^d Side
		in minutes			
Pork chops/Escalope	6	6-8	4-6	8-9	5-7
Fillet of pork	5	10-12	8-10	12-13	8-10
Sausages	6	6-8	4-6	8-10	5-7
Shashlik	4	7-8	5-6	8-10	7-10
Rissoles	4	8-10	6-8	10-15	10-12
Beef steak	6	4-6	3-5	6-7	4-6
Slices of liver	6	3-4	2-3	4-5	3-4
Escalope of veal	5	5-7	4-5	7-8	5-6
Veal steak	5	6-8	4-6	8-9	5-6
Mutton chops	5	8-10	6-8	10-11	7-8
Lamb chops	5	8-10	6-8	10-11	7-8
Half a chicken	3	10-12	8-10	14-15	10-11
Fillet of fish	6	6-7	4-5	7-8	5-6
Trout	4	4-7	3-6	8-11	5-6
Toast	5	2-3	2-3	2-3	2-3
Toasted sandwiches	4	6-8		6-8	

Defrosting

☞ Set the operating mode to Cold air convection  (Hot air convection without temperature setting) and do not countersink the mode selector so that the oven interior stays illuminated. The oven slightly heats up via the lighting - perfect for a mild defrosting.

☞ When defrosting ready to serve meals please follow the instructions of the producer.

- Remove the frozen food from the packaging, place it in a dish and insert into the oven with the rack on the third rack level from the bottom.
- Set the mode selector to  and the temperature control to "0" (resp. the instructions of the producer).

Preserving

⚠ Attention! Do not use jars with twist-off[®] lids if the latter have been already in use. The jars could otherwise smash under certain circumstances!

☞ Conventional preservative jars with a rubber ring and glass lid or standard jars with a twist-off[®] lid (only with new lid) are suitable. Metal cans are unsuitable.

☞ Do not pour water into the drip pan! A lot of steam would emerge from the vapour opening and you could burn yourself on it! Place a container of water in the drip pan, not on the bottom of the oven!

☞ Select Pizza mode .

- Only use fresh food and prepare according to the usual recipes.
- Prepare no more than 6 preserving jars with a capacity of 1 litres at one time.
- Only use jars of the same height and fill 3/4 full with the same contents.
- The jars should not touch each other.
- Place the drip pan on the 1st rack level from the bottom.
- Set 1 cup with water in the drip pan.
- Select Pizza mode  at 160 °C and observe preserving process. After 10 to 20 minutes (jars with a capacity of 1 l) the liquid in the jars will start to bubble, usually in the jar on the front right first.

Fruits

- Then switch off the oven and keep the jars in the closed oven for another 30 min. (approx. 15 min if preserving very sensitive fruit such as strawberries.)

Vegetables and meat

- When the liquid starts to bubble, turn the oven down to 100 °C and continue to heat for a further 60 to 90 minutes.

- Then switch off the oven and keep the jars in the closed oven for another 30 min.

The electronic timer

As well as providing a short-time alarm for reminders, the electronic timer controls the oven in several other ways. You can use it to set the cooking time and the finish time. All functions are available in any mode or temperature selection.

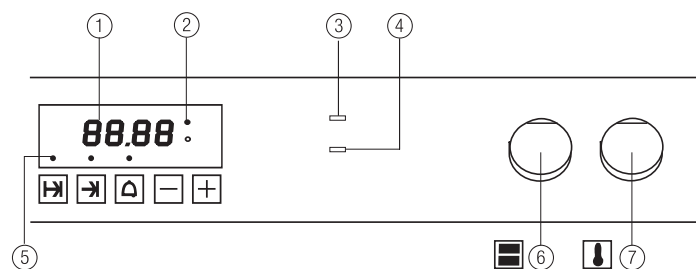

- Display:
- ① Time, alarm time (actual value in each case)
 - ② Lamps, showing that the oven is switched on.
 - ③ Pilot light (yellow)
 - ④ Heating-up indicator (red)
 - ⑤ Lamps (for each selector button/function)
- Selector buttons:
- ←|→ Cooking time
 - |→ Finish time
 - 🔔 Alarm time
- Adjust:
- +/- for altering the values of all functions.
 - ⑥ Mode selector
 - ⑦ Temperature control

Setting/changing the clock

- Push simultaneously “←|→” and “→|→”, until the time in the display flashes.

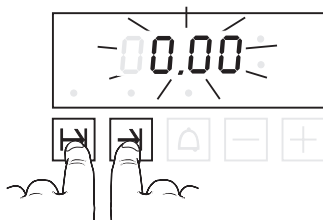

- Adjust as required using “+”/“–”.
- Wait for the display to stop flashing. The time will then be accepted, and the dot in the centre of the hour and the minutes will flash every second.

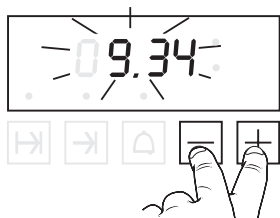

Setting the alarm time

You can use the alarm on its own, without effecting the oven.

- Press “🔔”. The lamp will flash. The display will read “0.00”.



- Use “+”/“–” to set the timer in minutes and seconds.
- Start the timer with “🔔” or wait until the lamp stops flashing. You will see in the display the time remaining until the buzzer sounds.



An acoustic signal is generated when the alarm time has elapsed.

- Press any button to stop the buzzer. The display will show the normal clock again.

This is how to programme the switching operations

1. Selecting the operation:

- Press the selector button for the operation you wish to use. The lamp above the button you have pressed will start to flash and a number will appear in the display.

2. Altering/adjusting the operation:

- Adjust the value shown, using “+” and “–”.

3. Starting the operation:

If you do not press another button for 3 seconds, the operation will commence automatically and the lamp will stay on all the time.

☞ You can reduce the time by pressing a selector button:

- the previously selected button confirms the input and starts the operation.
- another button confirms the input and selects the new operation you have chosen.

4. Setting the oven functions (switching functions only):

- Use ⑥ to select the mode and ⑦ to select the temperature. If you wish, you can set the temperature and mode before programming the timer.

Changing the setting

If you wish to alter a setting you have made – even if the operation is running – push the appropriate button again and use “+”/“–” to change the value in the display.

When the cooking time is finished

the oven will switch off and “End” will appear in the display. A warning signal will sound. Both of the lamps next to the display will stop flashing.



- Press any selector button to stop the alarm buzzer. The display will show the normal clock again. The oven starts again.
- Turn the temperature control and the mode selector switch to “0”.

Setting the cooking time \rightarrow (switch-off function)

The oven switches itself off when the pre-set time has elapsed.

- Press “ \rightarrow ” : the lamp will flash and “0.00” will appear in the display.



- Use “+”/“-” to set the cooking time in hours and minutes.



After approx. 3 secs. the timer will start and the lamp will stay on continuously. The display will show the time remaining. Both lamps will flash alternately.

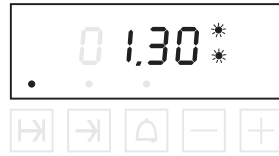

- Set the temperature and mode.

Setting the finish time \rightarrow (switch-off function)

Use this function if you want the oven to switch off automatically after a certain time.

- Press “ \rightarrow ” : the lamp will flash and “0.00” will appear in the display.

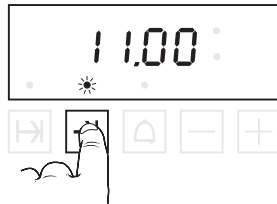

- Use “+”/“-” to set the desired switch-off time.

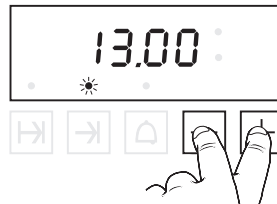

After approx. 3 secs. the timer will start and the lamp will stay on continuously. The display will show the time remaining. Both lamps will flash alternately.

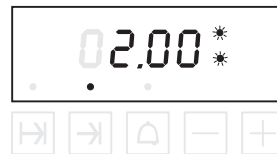

- Set the temperature and mode.

Automatic turn-on and shut-off

If you wish use the oven's time-delay feature, you may pre-select both cooking time and finish time. The automatic start time itself cannot be specified, but this is derived from both settings.

- It is impossible to set a finish time before the start time: you will hear a buzzer and the value in the display will not change. If you wish to shorten the cooking time you have set, do this first before you reset the finish time.

Example:

It is 8:00 and you wish to have your roast ready at 13:00. The roast needs to be cooked for 90 minutes.

Change the cooking time “ \rightarrow ” from 0.00 to 1.30. Then change the finish time “ \rightarrow ” from 9.30 to 13.00.

Once the times have been accepted, “Auto” will appear in the display and the oven will switch on at 11:30 and off at 13:00.

This is how to set the automatic switch-on and switch-off:

- Press “ \rightarrow ” : the lamp will flash and “0.00” will appear in the display.

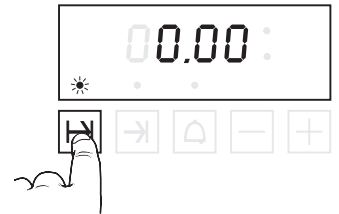

- Use “+”/“-” to set the cooking time in hours and minutes. (For example: 90 minutes)



- Press “ \rightarrow ” to confirm the input and select the finish time. The display will show a time (finish time if the oven is to switch on right away).

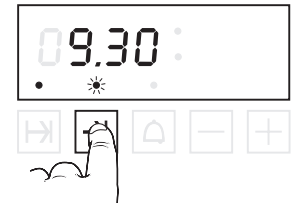

- Use “+” to set the finish time.



After approx. 3 secs. the lamps will stay on continuously. The display will show “Auto” until the oven switches on.



- Set the temperature and mode.

- The oven will automatically switch on at the specified time and both lamps next to the display will flash alternately. The time remaining until switch-off will be shown in the display.



Cleaning and care

You should carefully read this chapter before you use your appliance the first time. If cleaned correctly and looked after regularly the appliance will remain beautiful and clean for many years. Here you will find tips concerning the careful cleaning and of the individual surfaces and how to look after them.

For all surfaces

⚠ Steam and/or pressure cleaning machines must not be used to clean the appliance! This can damage the unit resulting in risk of **personal injury**.

⚠ **Risk of burning!** Make sure the appliance has cooled down before cleaning.

⚠ Please note the instructions of the cleaning agents.

Clean the appliance each time you use it. Not removed dirt will burn into the surface the next time you switch it on and these incrustations can often not be removed anymore.

Use a damp cloth or a soft sponge with warm water containing a small amount of detergent to clean light amounts of dirt from the surface. Always wipe off the surface completely with cold water to remove cleaning agents residues which could cause discolouring and stains. Wipe dry afterwards.

☞ You can find information in the following paragraphs concerning the individual surfaces and parts and how to remove heavy dirt.

☞ VSR O-FIX-C is perfect for the cleaning of glass ceramic, enamel and the coated inside of the door. You can obtain this cleaning agent from KÜPPERSBUSCH customer service.

Do not use any

- aggressive or bleaching cleaning agents containing for example active oxygen, chlorine or corrosive components.
- abrasive or aggressive cleaning or scouring agents such as steel wool, soap-impregnated steel wool, metal or plastic sponges or similar agents with an abrasive surface.

Remove caking

Heavy dirt should first be soaked – best with a wet cloth. Afterwards it is easier to remove the dirt.

Please note the information for the cleaning scraper

⚠ Caution! Risk of cutting! The blade of the cleaning scraper is very sharp! Always keep the cleaning scraper flat on the surface and push the caking away.

⚠ Do not scratch the surface with the edge of the scraper and take care not to damage the sealings with the edge.



The use of oven sprays - information

⚠ Please follow the instructions of the manufacturer. Oven sprays damage aluminium, lacquered surfaces and plastic!

⚠ Do not spray into the opening of the ventilator at the backplate! The ökotherm® catalyst will be destroyed if oven spray is used.

For environmental reasons you should not use oven spray at all. If you nevertheless want to use it, only spray it in the oven interior and on enamel baking trays.

Enamel

Oven interior, front, baking trays, drip pan, enamel hobs

Some plastic sponges with abrasive side can be used. Some products do however contain grains in the abrasive side of the sponge which can cause scratches.

Carefully try out the sponge on a small surface!

☞ A cleaning scraper for glass ceramic surfaces is suitable for removing heavy dirt.

☞ To thoroughly clean your appliance we recommend the use of VSR O-FIX-C. Oven spray may be used.

Stainless steel

Stainless steel door front, control panel, telescopic glide-out shelves (acc. No. 601), backmobil (acc. No. 600)

⚠ Stainless steel is very sensitive to scratches!
Do not use a cleaning scraper!

⚠ Remove any deposits of calcium or any spots of grease, and starch as soon as possible, or stains will appear!

For the cleaning a cleaning agent for stainless steel can be used.

We recommend to clean once a week stainless steel surfaces with an usual cleaning agent for stainless steel. This will create a protective film protecting the stainless steel surface from discolouring.

Glass

Inside of the door – coated glass

⚠ If possible, oven spray should not be used as it can cause the destruction of the coated glass surface when used frequently.

A cleaning scraper for glass ceramic surfaces is suitable for removing heavy dirt.

☞ To thoroughly clean your appliance we recommend the use of VSR O-FIX-C or glass detergent.

Door front, control panel

☞ Clean the **oven front** with warm water containing a small amount of detergent, with a damp cloth or a soft sponge. Do not use glass cleaning agents.

Aluminium

Door ledges and handles in aluminium, baking tray (acc. No. 543)

⚠ Aluminium is very sensitive to scratches and oven spray causes damage!

Do not use a cleaning scraper!

Door sealing

☞ The door sealing should be removed when cleaning the oven to avoid that dirt can collect under the sealing. See page 31 "Replacing the door sealing".

If necessary the sealing can be cleaned with detergent or washing-up liquid.

Buttons

Clean the buttons with warm water containing a small amount of detergent, with a damp cloth or a soft sponge.

Removing and installing the oven door

Removing the oven door

- Open the oven door as wide as it will go.
- Fold forward the clamps on the door hinges.

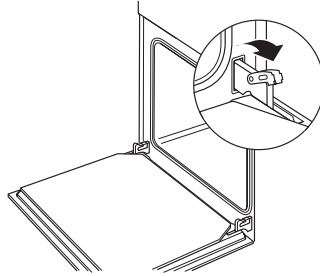

- Take hold of the oven door on the both sides and close it almost completely.

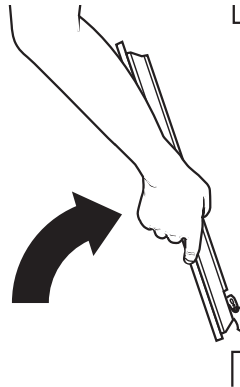

- Gently lift the door and pull the hinges forward away from the door opening.

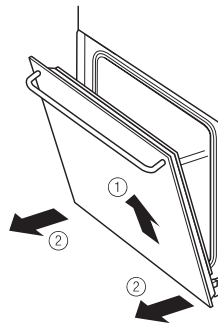

Reassembling the oven door

- Take hold of the oven door on both sides and push the hinges into the relevant holes on the oven. The hinge will click into place.

- Slowly open the oven door full.

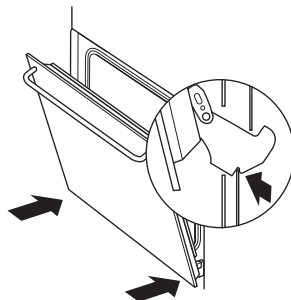

- Fold back the clamps on the door hinges.

- Close the oven door.

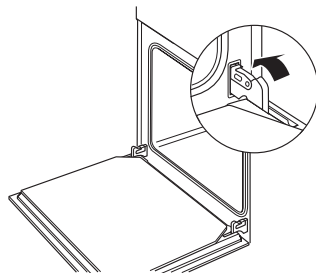

Removing and installing the side racks

Removing the side racks.

- Loosen the screws.
- Remove the slot-in racks.

Installing side racks

- Insert side racks and tighten down in front.

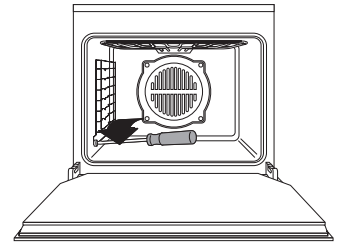

Folding heating element down/up

Folding heating element (top heat/grill) down

- Open lock and fold heating element down.

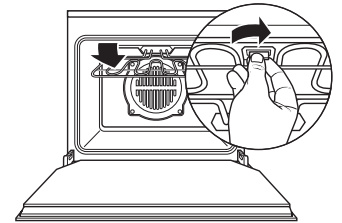

Folding heating element up

- Fold heating element up and close again with the lock.

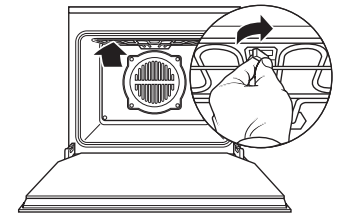

Regenerating the ökotherm[®] catalyst

- Set the mode selector to Hot air convection .
- Set the temperature control to "▼▼" and
- Heat the empty oven for 60 minutes.

What to do if trouble occurs...

⚠ Repairs may only be carried out by a qualified technician!

You can deal with some problems that occur yourself. First check whether there has been any operating error. Repairs during the guarantee period are not free of charge, when they are caused by operating errors or non-observance of the following instructions:

Fault	Cause	Remedy
Not possible to switch off the oven.	Electronic component defective.	Disconnect fuse, call customer service.
Oven does not heat up.	Fuse defective.	Check and replace fuse, if necessary.
	Is the mains plug in the wall socket?	Plug the mains plug into the wall socket
	Oven temperature control or mode selector has not been switched on.	Set oven temperature control or mode selector as required.
	Electronic timer flashing – the clock has not yet been set.	Set the clock. See page 21.
Oven light no longer works.	Lighting defective.	Replace the oven lamp.
Glass of oven door broken.		Switch off the appliance, call customer service.
Door sealing damaged.		Replace the door sealing.
Strong smells from oven in spite of ökotherm [®] catalyst.	ökotherm [®] catalyst must be regenerated.	Heat the empty oven by intensive hot air convection at 275 °C for 60 min.
Strong vinegar smell when preparing.	Baking with sour dough or with yeast, food containing alcohol and using a fan-assisted mode.	Use a mode without fan-assistance, e.g., top heat/ bottom heat.
Fruit juice or protein stains on enamelled parts.	Moist cake or meat juices.	Harmless changes in the enamel, cannot be remedied.

Replacing the oven lamp

⚠ **Caution: Danger of electric shock!** Before you open the cover of the oven lamp the appliance has to be disconnected from the electricity supply: Switch off the fuse or pull out the mains plug!

⚠ The lamps become very hot after being in use for some time. Therefore, the lamps should be changed when they have cooled down!

Type: 25 W, 230/240 V, socket: E14

Important: **temperature resistant up to 300 °C!**

You can obtain these lamps from KÜPPERSBUSCH customer service or from your dealer.

Changing the light bulb:

– Unscrew the shelf rack.

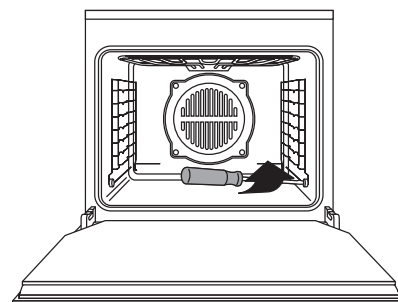

– Carefully lever out the glass cover with a screwdriver.

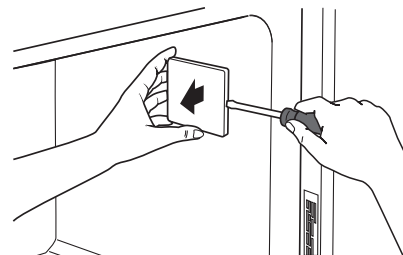

– Remove the damaged light bulb and put the new one in.
– Reinstall the glass cover.

Replacing the door sealing

⚠ Do not use the oven with damaged or missing door sealing! If the sealing is damaged or cannot be cleaned anymore it has to be replaced. You can obtain a new sealing from KÜPPERSBUSCH customer service.

Removing the sealing

– To remove the sealing gently pull each corner out.

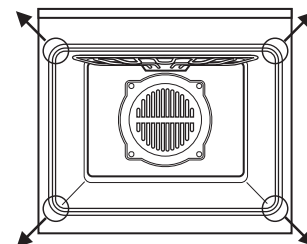

Fitting the new sealing

– Clasp one corner after the other into the oven front.
Take care not to deform the hooks!

Rating label

Always indicate the data provided on the rating label when calling in customer service or ordering spare parts.

The rating label for the oven is located on the right-hand side strip and is visible when the oven door is open.

– Make a note of this information in case you have to consult our customer service.

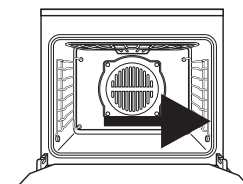

Production-no. oven:											
Model designation oven											

Installation instructions for fitter

- Only KÜPPERSBUSCH built-in hobs were designed and tested for use above a Küpperbusch fitted oven. No other hobs may be used.
- Statutory regulations and the connection specifications issued by the local power supply company must be strictly observed.
- Switch off the appliance by means of these safety devices before connecting up the oven, carrying out repair work or replacing the oven light bulb. Disconnect the appliance from the mains, disconnect fuse.
- It must not be possible to touch components which are insulated under operating conditions.
- The earth wire must be so long that if the mains lead cleat fails, the live wires of the connecting cable are subjected to tension before the earth wire.
- The unit is ready to plug in and may be connected only to a properly installed protected socket. Installing and wiring a socket or replacing the connection cable should only be performed by an electrician and in observance of the relevant regulations.
- If the socket is inaccessible after the installation, safety regulations require that an all-pole isolator with a contact opening of at least 3 mm be used on the installation side.
- The socket for plugging in the unit must be outside the installation space.
- Built-in kitchen fixtures must be temperature resistant to 100 °C. This applies especially to veneers, plastic coatings, adhesives and varnishes. Adjacent cabinetry front must be temperature resistant to at least 70 °C.
- The unit must be installed absolutely horizontal on a level, solid base. The base must not be allowed to sag.
- If the cupboard element is not attached to the way, screw on using an ordinary bracket.

Electrics

⚠ WARNING! This appliance must be earthed!

Electrical requirements (for UK and Republic of Ireland only)

Check that the voltage stamped on the rating plate corresponds with your house electricity supply, which must be AC (alternating current).

Electrical connection of the appliance must be performed by a trained electrician. The legally recognized regulations and the connection requirements of the electricity board serving your area must be fully complied with.

⚠ WARNING! Should the oven be supplied with a continental two-pin plug fitted, then this plug must be cut off from the connection cable. Dispose of the plug safely; do not insert it in a 13 A socket elsewhere in the house as this could cause a shock hazard.

Connection for UK and Republic of Ireland only: Permanent connection to an oven power point (fuse: 20 A!).

Other countries:

Connection	is via the mains plug into a wall socket.
Total rating	at 230 V: 3.5 kW, at 235 V: 3.6 kW
Electrical connection	230 - 240 V, 50 Hz
Fuse current	16 A

Installation dimensions

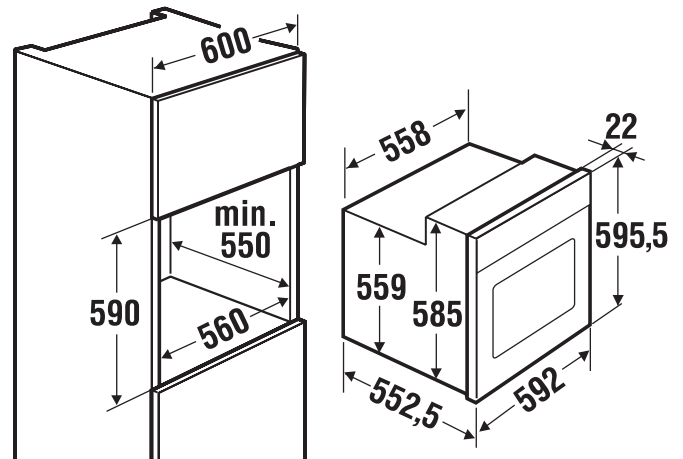

Installation in a fitted kitchen

Installing the appliance (not correct for UK and Republic of Ireland!)

- Plug into the wall socket.
- (UK and Republic of Ireland: Connect to an oven power point!)**
- Push the oven right into the cupboard alcove. Do not jam the cooker connection!

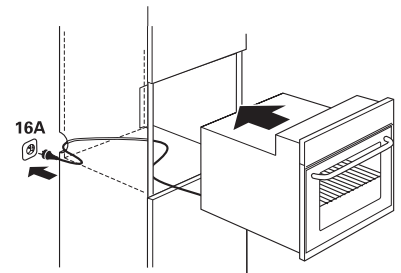

Fastening the appliance

- Open the oven door and fix the screws supplied at an angle through the cupboard.

