

Hauptschalter

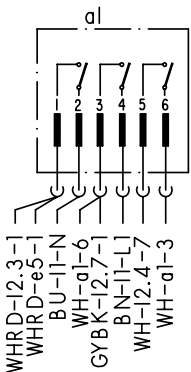

Zugabe

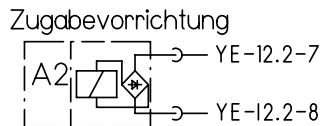

Zeitvorwahl, Bedien- u. Steuermodul

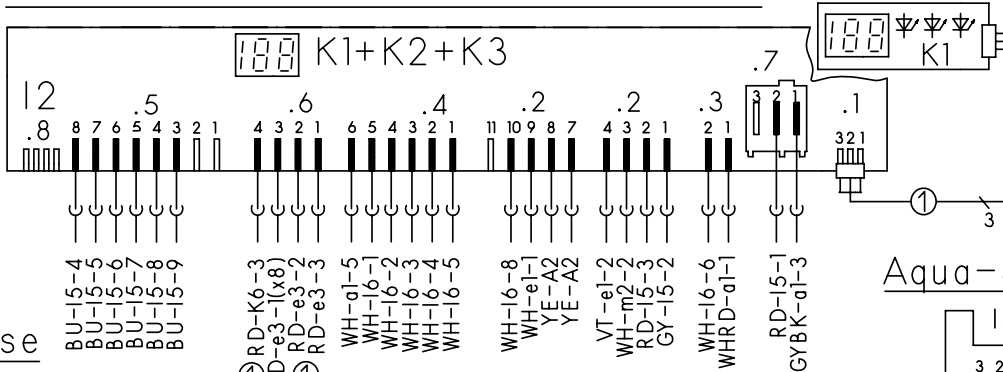

Sensoren

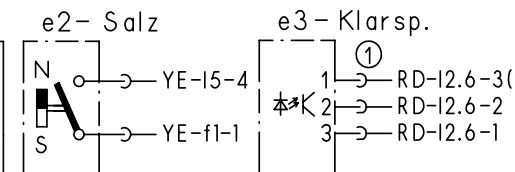

Niveaudruckdose

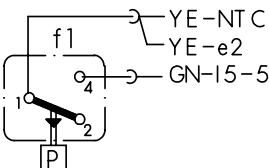

Temp.-regler + NTC

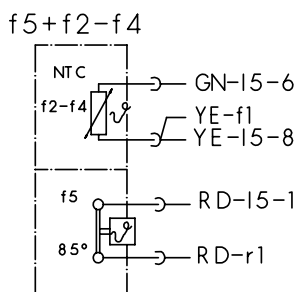

Schutzleiter

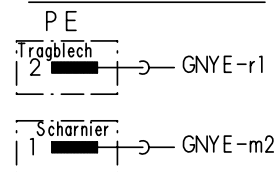

Aqua-Sensor

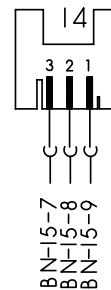

Splice ①

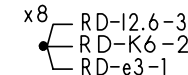

Kupplung

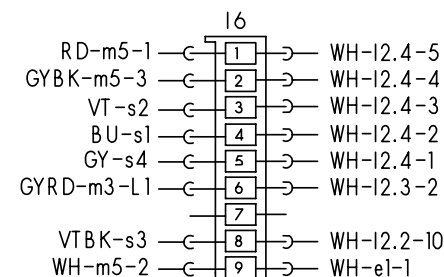

Türschalter

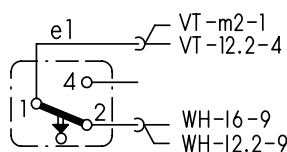

Magnetventile

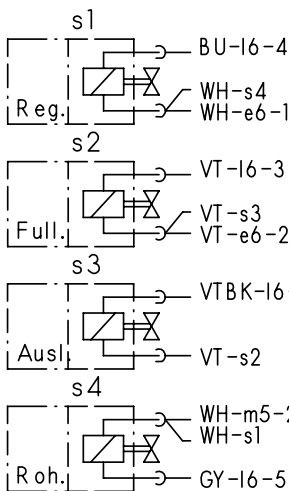

Schwimmersch.

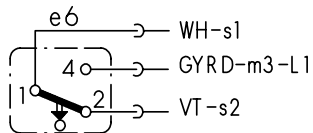

Anlass-PTC

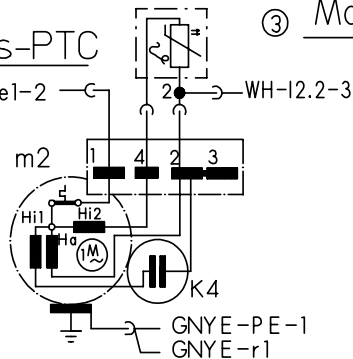

Motor ③

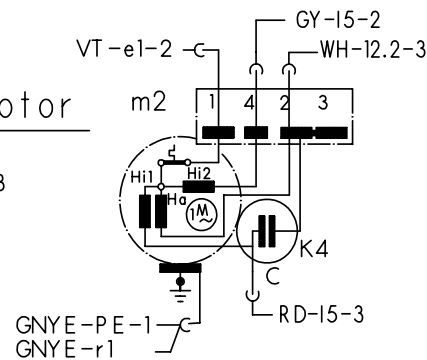

Wasserweiche

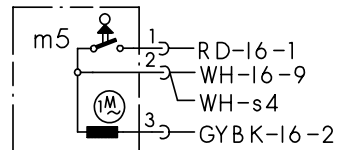

Klemme I1 mit Entstoerung

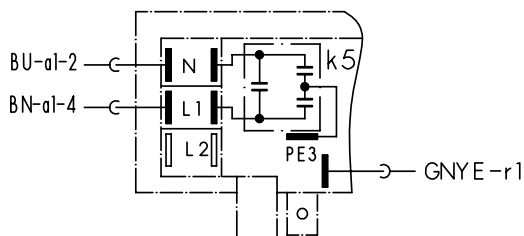

Info-Light ①

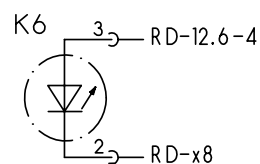

Heizung

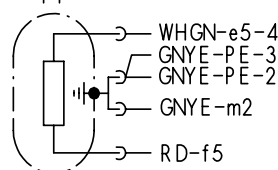

Sicherheitssch.

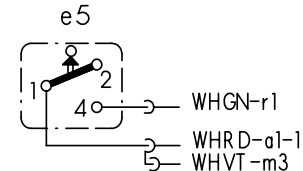

Laugenpumpe

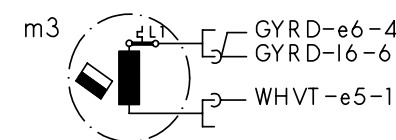

③ je nach Motortyp
 ① je nach Ausstattung vorhanden
 ② wenn vorhanden ohne Funktion



Mat.Nr.: 9000009361	
Ausg.: 02.04	S0-60/0812