

main switch

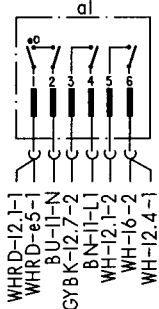

service and control module

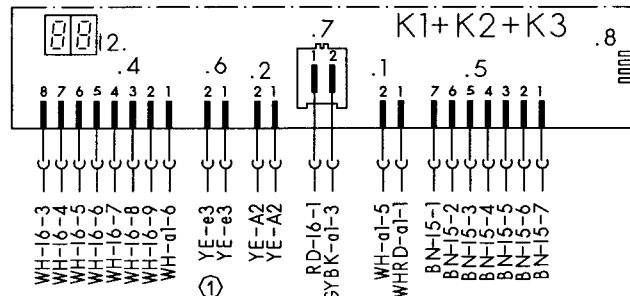

reed switch

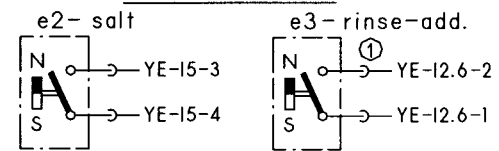

earth terminal

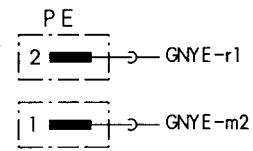

aqua-sensor



clutch

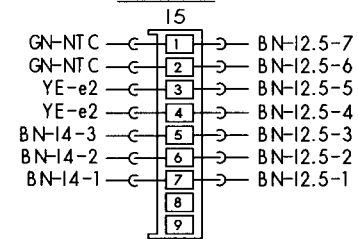

water points

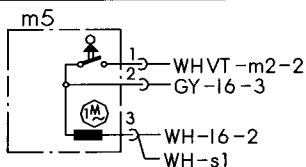

level switch

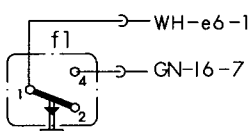

thermostat + NTC

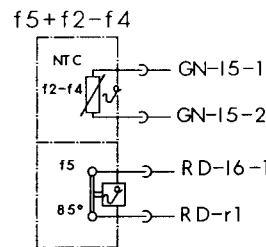

aktuator

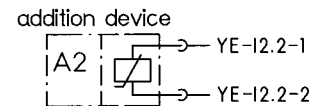

solenoid valves

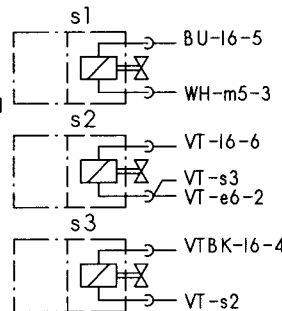

float switch

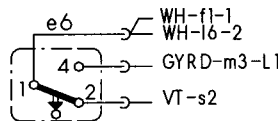

capacitor motor

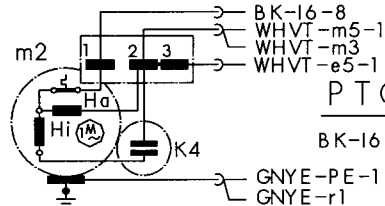

PTC-motor

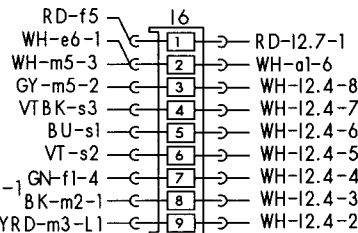
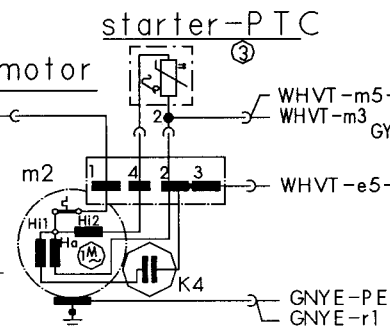

drain pump

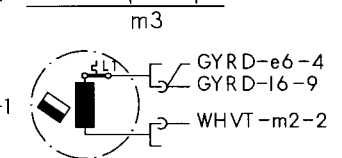

terminal I1 with interference suppression

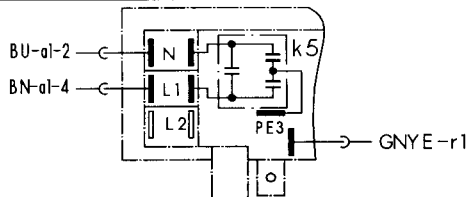

heating

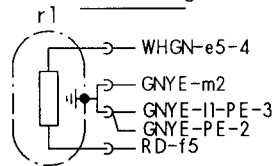

safety switch

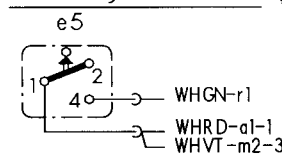

① exist according to equipment

③ according to motortyp



Mat.Nr.: 5600042480	
Ausg.: 03.01	SO-60/ 0600

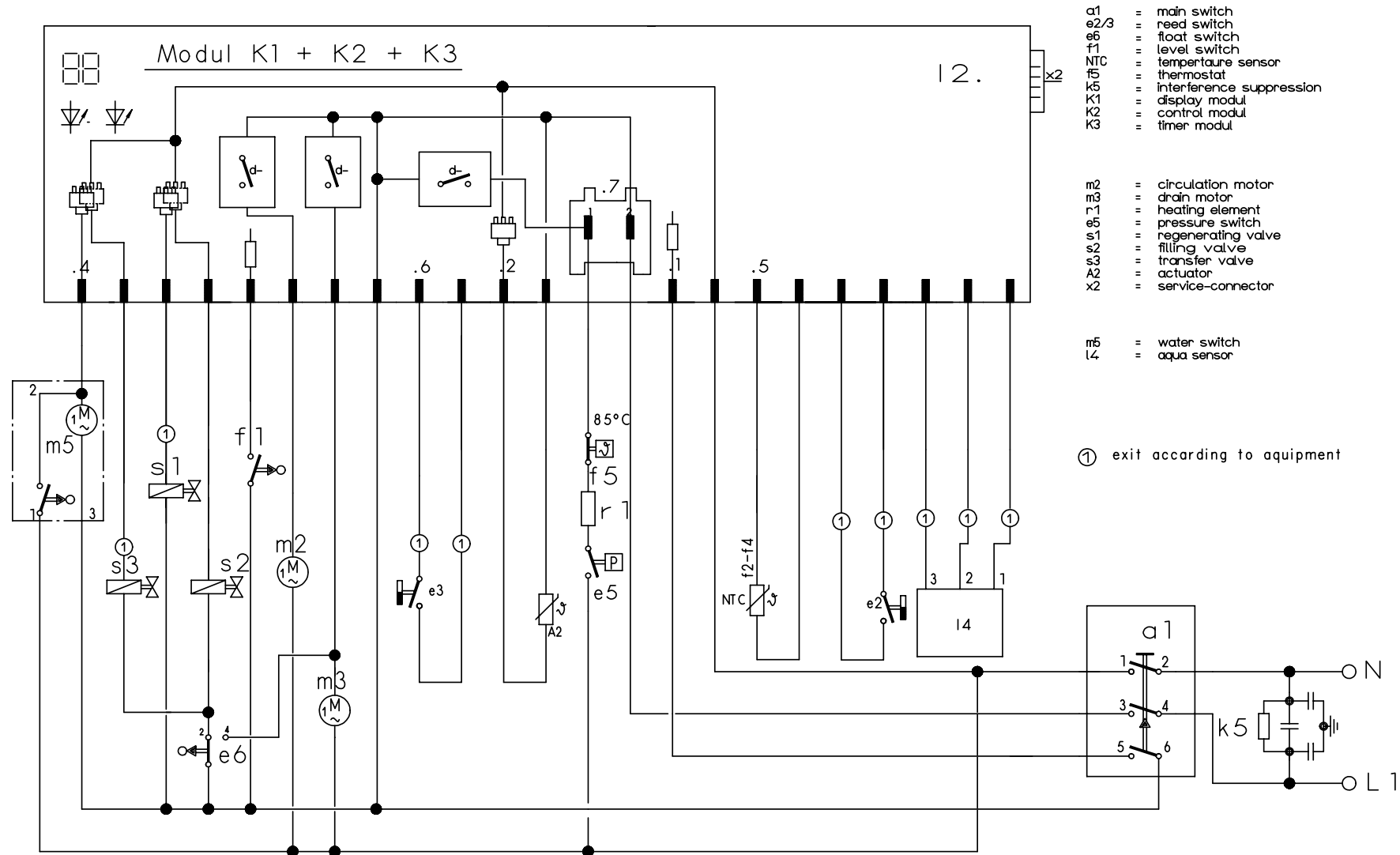

Mat. Nr. 5600042479	
Ausg.: 02.01	S0-60/0594

