

main switch

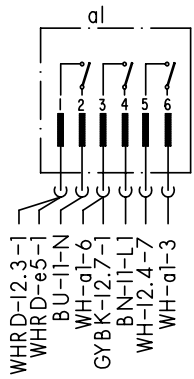

aktuator

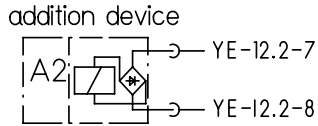

level switch

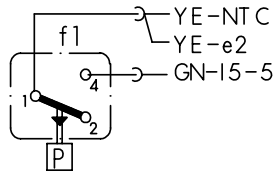

door switch

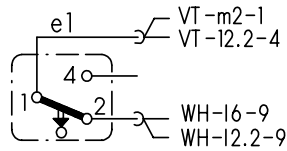

float switch

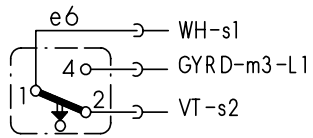

water points

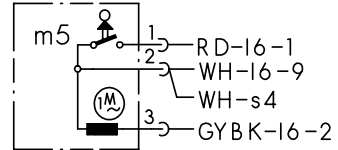

terminal 11 with interference suppression

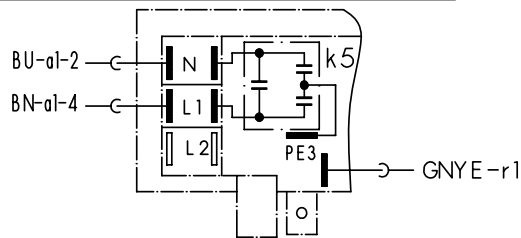

time delay, display and control unit

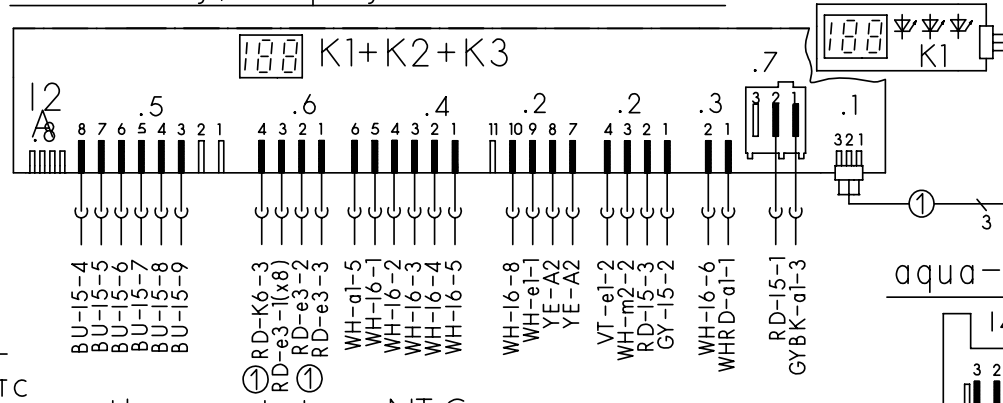

sensor

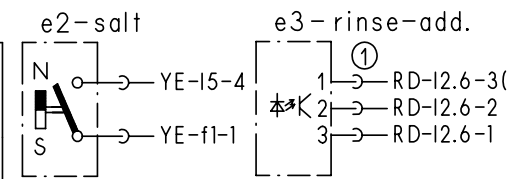

Splice ①

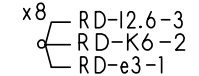

aqua-sensor

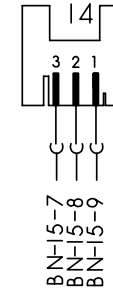

clutch

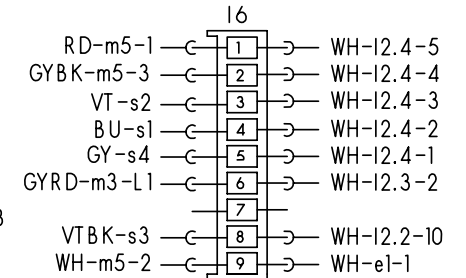

thermostat + NTC

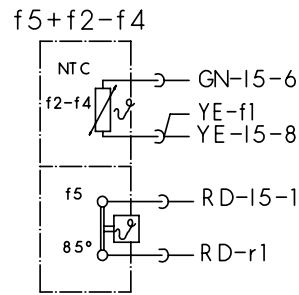

earth terminal

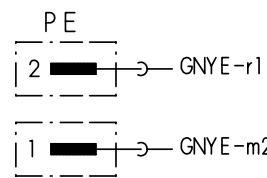

solenoid valves

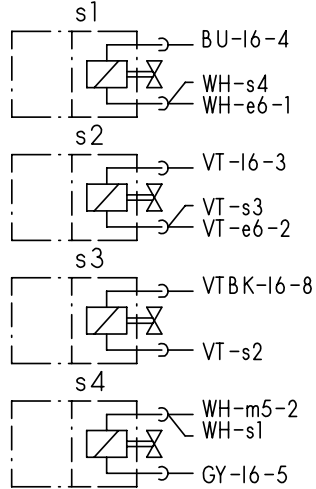

starter-PTC

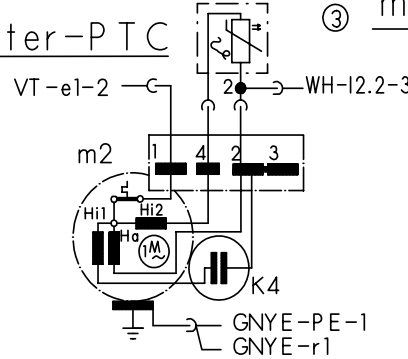

motor

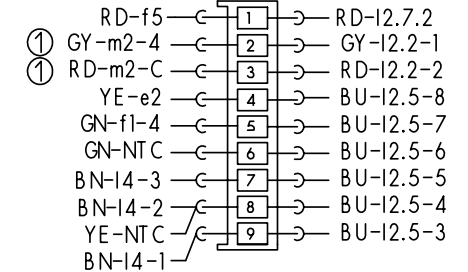
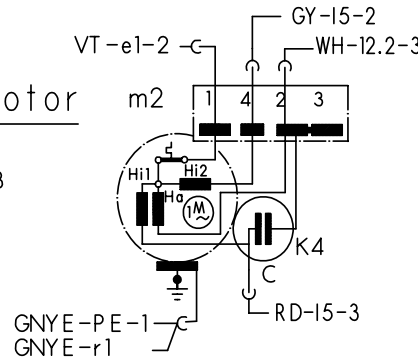

Info-Light ①

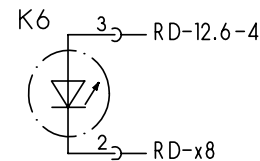

heating

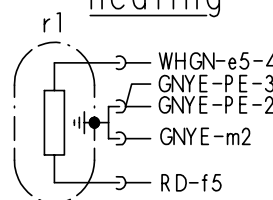

safety switch

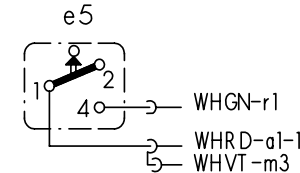

drain pump

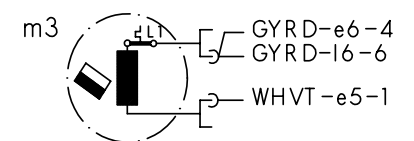

① exist according to equipment
 ② if exist without function
 ③ according to motortyp



Mat.Nr.: 9000009361	
Ausg.: 02.04	S0-60/0812